

CATALOGUE

C72

COLNAGO

C72



The legend of the C series

This bike is 100% made in Italy. From tube design and manufacturing to frame assembly and painting, everything happens in Italy. Frame construction is carried out in Cambiogo, at Colnago HQ. After painting—done at Colnago's facilities in Pisa—the bike returns to Cambiogo for final assembly.

GEOMETRY

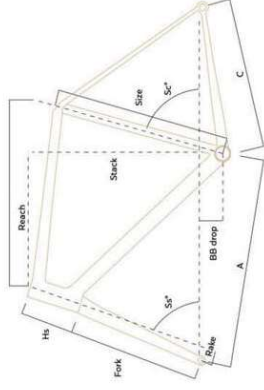

Size	Ss*	Sc*	Reach	Stack	Fork	Rake	Trail (30-622 Tyre)	Hs	Wheelbase C	Standover A	BB drop	O	
420	70,8	75,5	370	512	377	45	73,2	101	971	408	679	575	505
455	71,6	75,3	375	525	377	45	68,0	112	974	408	713	577	514
485	72,5	74,8	382	543	377	45	62,2	129,5	979	408	740	582	526
510	72,9	74,5	387	562	377	45	59,7	148	988	410	762	589	543
530	72,9	73,8	394	580	377	45	59,7	167	1001	410	781	602	563
550	72,9	73,5	402	599	377	45	59,7	187	1017	412	802	615	577
570	72,9	73,3	409	619	377	45	59,7	207	1030	412	820	628	591

Framesize Incl HB size

CC.02	Frame Size
CC.02-090-390	42.0s
CC.02-100-390	45.5s
CC.02-110-390	48.5s
CC.02-110-410	51.0s
CC.02-120-410	53.0s
CC.02-120-410	55.0s
CC.02-130-40	57.0s

Compatibility

- Compatible only with the D-shape steering tube of C72

Performance

- Weight: approx. 10 g lighter than CC.01
- Improved stiffness.

Installation & integration

- Dedicated system to support precise handlebar alignment
- Traditional installation with lateral screws

Updated ergonomics (vs CC.01)

- Based on feedback on CC.01, the bend/shape has been revised to:
 - prevent some riders from hitting their wrist, against the bar while in the drops
 - deliver a more vertical, natural grip in the drops position

The handlebar geometry has been updated accordingly to improve comfort and control in the drops.

Frame kit C72: €6.839.00 Incl HB CC.02

Groupset		Wheels	MSRP
Campagnolo Super Record WRL 13v		Campagnolo Bora ULTRA WTO 45 DB	€ 15,400.00
Shimano Dura Ace R9270 Di2 Disc		Enve WS SES 4.5 C	€ 15,900.00
Shimano Dura Ace R9270 Di2 Disc		Fulcrum Sharq 57	€ 14,200.00
Sram Red AXS E1 PM		Enve WS SES 4.5 C	€ 17,100.00

COLOR CODE: HFTB



COLOR CODE: HFRD



COLOR CODE: HFBK



COLOR CODE: HFWS



C68 Gravel

COLNAGO

PIRELLI



Scan the QR code for the most updated technical information
 Scansiona il codice QR per le informazioni tecniche più aggiornate

C68 Gravel



A gravel bike unlike any other

The C68 Gravel is the ultimate Colnago Gravel bike, a masterpiece that embodies the perfect fusion of Colnago technology and timeless Italian craftsmanship. It comes with a different geometry to the C68 Road, offering an optimal handling and riding position, perfectly poised for challenging landscapes, while maintaining an overall aggressive position. Keeping true to the Colnago spirit, it's a gravel bike designed for fast gravel.

Una bici da gravel unica, diversa da tutte le altre

La C68 Gravel è una bicicletta sofisticata, elegante, capace di interpretare ed esprimere al meglio il marchio Colnago, il miglior trade-off tra Bellezza e Performance. Presenta una geometria diversa rispetto al C68 Road, per garantire una maneggevolezza e una guidabilità perfettamente bilanciata per affrontare strade sterrate e largose, pur mantenendo un assetto complessivamente aggressivo. Come da spirito Colnago, è una bici pensata per il gravel veloce.

GEOMETRY

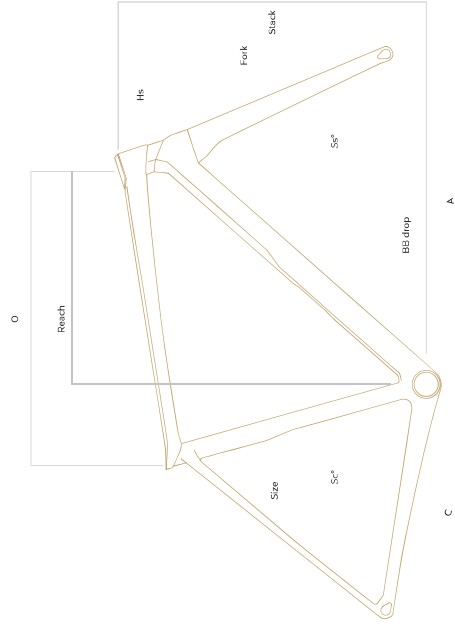

Size	Cf	Fork	Rake	Sc°	A	C	Hs	Ss°	BBdrop	O	Stack	Reach
450	450	409	48	75	596	425	115	70,5	74	520	541	375
480	480	409	48	74	612	425	130	70,5	74	545	555	386
510	510	409	48	73,5	632	425	157	70,5	72	569	580	397
540	540	409	48	73,2	652	425	185	70,5	72	590	605	408
570	570	409	48	73	660	425	212	70,5	72	600	630	419

MAX NOMINAL TIRE CLEARANCE: 42 mm



COLOR CODE: **HGGR**

C68 Gravel

Groupset	Wheels	MSRP
Sram RED XPLR 13v	ZIPP 303S	€ 12.010,00
Sram Force XPLR	VISIONSC45	€8.850,00
Shimano GRX 825 2x	VISIONSC45	€8.850,00
Shimano GRX 822 1x	Fulcrum Rapid Red 900 DB	€7.250,00

Frame kit C68 Gravel: **€5.935**COLOR CODE: **HGBK**COLOR CODE: **HGWH**

THE IMAGES SHOWN ARE INDICATIVE ONLY.
Components and graphic details may differ from the actual model.

C68 Rimbrake

C series

COLNAGO



C68 Rimbrake



A product for people with a sophisticated cycling culture.

The Colnago Rim Brake is a product born out of passion and love for cycling. It is a frame that transcends time and trends. Because of its special and niche nature, very few people will be able to boast of owning one.



THE IMAGES SHOWN ARE INDICATIVE ONLY.
Components and graphic details may differ from the actual model.

GEOMETRY

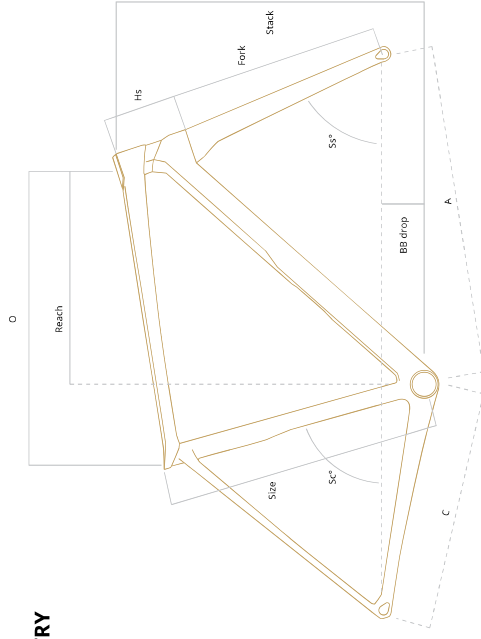

Size	Fork	Sc°	A	C	Hs	Ss°	BBdrop	O	Stack	Reach
R420	379	75,5	576	408	103	70,6	72	504	510	370
R455	379	75	582	408	114	71	72	517	522	375
R485	379	74,5	591	408	130	71,5	72	535	539	383
R510	379	74	599	410	148	71,8	72	550	557	388
R530	379	73,5	605	414	164	72,5	72	567	575	395
R550	379	73	614,5	414	181	72,9	72	586	593	403
R570	379	73	625	414	200	73,1	72	599	612	410

Frame kit C68 Road: €6.930

Master

Master

COLNAGO



Master



The pride of owning a timeless classic

First produced in the early 1980s, the steel Master frame is the classic par excellence in the history of great cycling. It has achieved unforgettable victories with legendary champions. The Master frame is still built entirely in Italy and is still made from the iconic Colnago DT15V steel tubes, with the characteristic star-shaped tube cross-section.



THE IMAGES SHOWN ARE INDICATIVE ONLY.
Components and graphic details may differ from the actual model.

GEOMETRY

Master

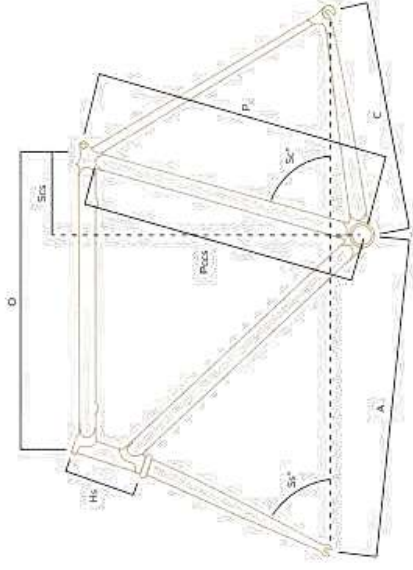

Traditional

Size	P	O	Pccs	Scs	Sc ^p	A	C	Hs
49	490	518	470	121	75	585	400	80
50	500	523	480	125	75	587	401	83
51	510	527	490	128	74,8	587	402	91
52	520	530	500	133	74,6	588	403	99
53	530	535	510	140	74,1	589	404	108
54	540	540	520	143	74	591	405	117
55	550	545	530	146	74	594	406	126
56	560	550	540	153	74	595	408	135
57	570	557	550	161	73,5	595	410	143
58	580	565	560	165	73	597	411	151
59	590	572	570	169	73	600	412	160
60	600	580	570	169	72,75	608	413	162
61	610	586	583	173	72,75	612	413	171
62	620	590	583	173	72,75	615	414	182
63	630	594	586	174	72,75	618	415	182
64	640	597	595	177	72,75	622	416	192
65	650	600	605	180	72,75	624	416	203

Frame kit Master: €2.750

V5RS



V5RS



most updated technical info
Scan the QR code for the
Scansiona il codice QR per le
informazioni tecniche più aggiornate



A race bike built to win, refined for every detail.
The V5RS is 12.5% lighter, more aerodynamic, and just as stiff as the V4RS. Engineered for pro-level performance with optimized handling, sprint power, and all-day comfort—uphill, downhill, and everywhere in between.

Costruita per vincere. Perfezionata in ogni dettaglio. La V5RS è più leggera del 12,5%, più aerodinamica e altrettanto rigida rispetto alla V4RS. Progettata per prestazioni di livello professionale, con maneggevolezza ottimizzata, pazienza in valata e comfort per tutto il giorno—in salita, in discesa e ovunque nel mezzo.

GEOMETRY

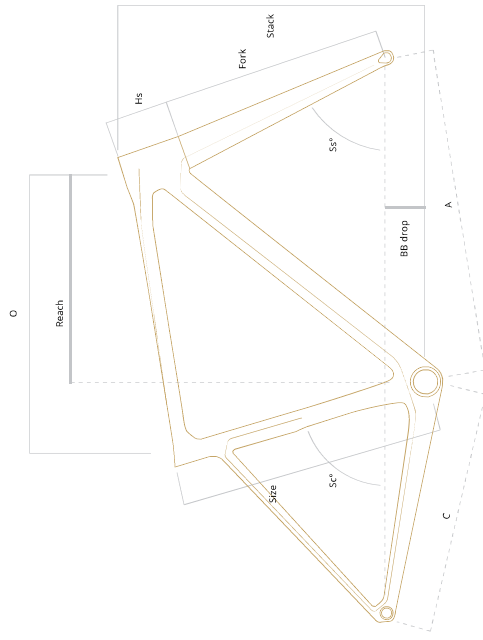

Sloping

Size	Ht angle	St angle	Reach	Stack	Fork length	Rake	Trail (28-622 tyre)	Ht Length	Wheel-base	Css length	Front center	Bb drop
420	70,6	75,5	371	509	377	47	70	101	975	408	579	74
455	71,5	75,3	377	523	377	47	65	112	978	408	581,5	74
485	72,3	74,8	384	539	377	47	59,5	127	984	408	586,5	72
510	72,5	74,5	390	557	377	47	58,5	146	994	408	596,5	72
530	73	73,8	397	575	377	47	59,5	162	997	408	600	72
550	73	73,5	404	593	377	47	59,5	181	1010	408	612,5	72
570	73,5	73,5	411	612	377	47	57,5	199	1019	408	622	72



frame kit V5Rs: € 5.940,00

5Rs

Groupset		Wheels	
Shimano Dura Ace R9270 Di2 Disc		Enve WS SES 4.5 C	€ 15.900,00
Shimano Dura Ace R9270 Di2 Disc		Shimano Dura Ace C50 WHR9270	€ 14.540,00
Shimano Dura Ace R9270 Di2 Disc		VISION SC 45	€ 12.800,00
Shimano Ultegra R8170 Di2 Disc		VISION SC 45	€ 10.800,00

COLOR CODE:SDM5



COLOR CODE:VRBK



V5Rs

COLOR CODE:VRWB



COLOR CODE:VRWC



COLOR CODE: SDM6



COLOR CODE: STBU



COLOR CODE: STNT



V series

V4RS

COLNAGO

Emirates



P ZERO RACE TLR
34





Scan the QR code for the most updated technical information
Scansiona il codice QR per le informazioni tecniche più aggiornate

V4Rs



Built to Win

The Colnago V4Rs is the road racing bicycle created by Colnago in collaboration with UAE Team Emirates and UAE Team ADQ, designed to deliver top-level performance and excel in the WorldTour. It's the evolution of the already successful V3Rs, with improved stiffness, better aerodynamics and a weight decrease.

Costruita per Vincere

La Colnago V4Rs è la bicicletta da corsa realizzata da Colnago in collaborazione con UAE Team Emirates e UAE Team ADQ, progettata per dare performance di altissimo livello e vincere nel WorldTour. È l'evoluzione della già vincente V3Rs, ma ancora più rigida, più dinamica e più leggera.

GEOMETRY

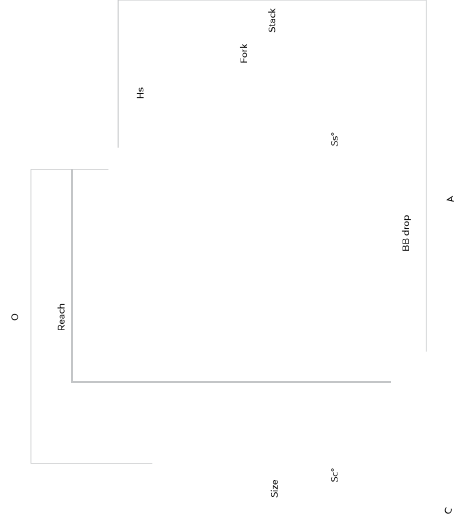

Sloping

Size	Cf	Fork	Rake	Sc ^c	A	C	Hs	Ss ^c	BBdrop	O	Stack	Reach	Real Reach
420	420	379	43	75,5	576	408	103	70,6	72	504	510	370	372
455	455	379	43	75	582	408	114	71	72	517	522	375	377
485	485	379	43	74,5	591	408	130	71,5	72	535	539	383	385
510	510	379	43	74	597	408	148	71,8	72	550	557	388	390
530	530	379	43	73,5	599	408	164	72,5	72	567	575	395	397
550	550	379	43	73	608	408	181	72,9	72	586	593	403	405

MAX NOMINAL TIRE CLEARANCE: 30 mm



Frame kit V4Rs: €5.250

Groupset	Wheels	MSRP
Campagnolo Super Record WRL	Campagnolo Bora UL TRA WTO 45 DB	€ 15.390,00
Shimano Dura Ace R9270 Di2 Disc	ENVE WS SES 3.4C	€ 14.540,00
Shimano Dura Ace R9270 Di2 Disc	Shimano Dura Ace C50 WHR9270	€ 12.990,00
Shimano Dura Ace R9270 Di2 Disc	VISION SC45	€ 11.500,00
Shimano Ultegra R8170 Di2 Disc	VISION SC45	€ 9.090,00
Stam RED AXS E1 PM	VISION SC45	€ 12.385,00
Stam Force AXS Disc	VISION SC45	€ 8.790,00

COLOR CODE: WC24

Supplement :€ 300



COLOR CODE: SDM4



COLOR CODE: WT24



THE IMAGES SHOWN ARE INDICATIVE ONLY.
Components and graphic details may differ from the actual model

COLOR CODE: RVLM

V4Rs



COLOR CODE: RVWO



COLOR CODE: RVBU

V4Rs



COLOR CODE: RVBO



THE IMAGES SHOWN ARE INDICATIVE ONLY.
Components and graphic details may differ from the actual model.

THE IMAGES SHOWN ARE INDICATIVE ONLY.
Components and graphic details may differ from the actual model.

Y1RS

COLNAGO





most updated technical info
Scan the QR code for the
Scansion il codice QR per le
informazioni tecniche più aggiornate

Y1RS



Built to defy air

The Colnago Y1Rs is engineered to be the most aerodynamic bike in the World Tour, designed to excel in both Classics and Grand Tours.

By leveraging new UCI regulations, it achieves unparalleled performance against air resistance.

Revolutionary Aerodynamics

Frontal Area: A thinner headtube and innovative CC-Y1 handlebar reduce frontal drag by 15%, setting a new benchmark for aerodynamics.

Downtube Design: Using advanced CFD modeling and research with Politecnico di Milano, the downtube now features a mixed shape optimized to channel airflow and minimize drag.

Innovative Components

Headset: Enhanced lateral surfaces improve airflow, with a reimagined fork and compact bearings for superior aerodynamics.

Seatpost Design: The double Y-shaped seatpost and seat tube ensure improved comfort and vertical compliance, ideal for long rides.

Efficiency at the Core

The Y1Rs incorporates a BSA bottom bracket for reduced weight and added stiffness, ensuring peak performance in every race.

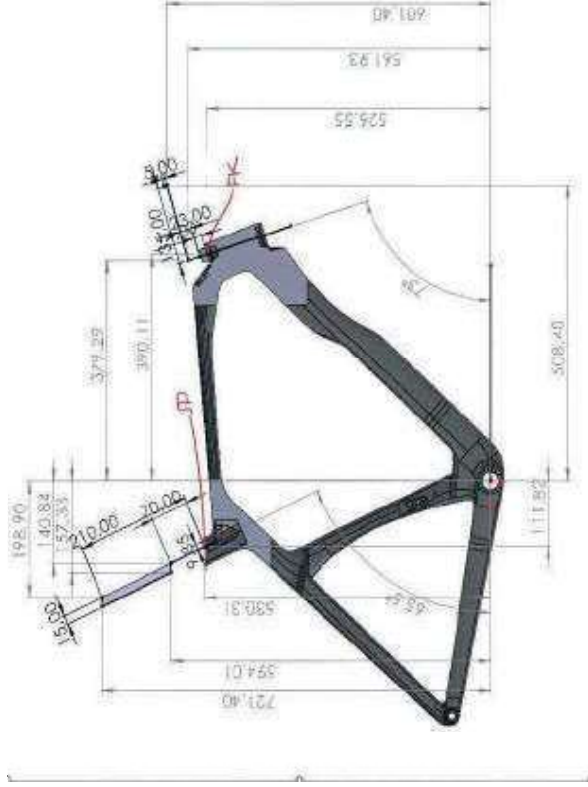

Size	HT angle	ST angle	Reach	Stack	Fork length	Rake	TRAIL (28-622 TYRE)	HT length	Wheel base	CS Length	Front center	BB drop
XS	70.8	75	368	495	376.5	55	61	88.5	974	408	577.5	74
S	71.9	74.5	377	520	376.5	49.5	59.5	108.5	976	408	579.5	74
M	73	74	386	540	376.5	45	57.5	126.5	978	408	581	72
L	73.5	73.7	395	565	376.5	42.5	57	150.5	987	408	590	72
XL	73.5	73	404	590	376.5	42.5	57	176.5	1003	408	606	72



Y1RS



COLOR : YSBO



COLOR : YSBC
Supplement: € 300



COLOR : YSWC
Supplement: € 300

Y1RS



COLOR : YSWW



COLOR : SDMS

THE IMAGES SHOWN ARE INDICATIVE ONLY.
Components and graphic details may differ from the actual model.



STEELNOVO

COLNAGO

COLNAGO

STEELNOVO

COLNAGO
STEELNOVO
ST
COLNAGO

COLNAGO

COLOR CODE: SNLB



COLOR CODE: SNPP



A tribute to 70 years of Colnago craftsmanship, the Steelnovo Settanta blends Italian tradition with modern innovation.

This limited edition bike, featuring only 70 pieces, celebrates Colnago's founding in 1954 and comes equipped with a custom Campagnolo Super Record Wireless groupset, adorned with Italian flags to honor its heritage.

Timeless Design, Modern Technology

Steel Frame: Crafted using traditional Italian brazing techniques, with tubes developed in collaboration with Columbus for custom shaping and bending.

3D-Printed Joints: Advanced lugs and joints, designed with Additiva Lab, ensure robust connections, lightweight performance, and seamless tube integration.

Performance and Comfort

Racing Precision: Oversized headset and T47 bottom bracket deliver stiffness, quick handling, and smooth acceleration.

Tire Clearance: Supports up to 35mm tires, ideal for endurance rides or speed-focused setups.

Versatile Geometry: Optimized for both comfortable long-distance rides and aggressive racing positions.

Tradition Meets Innovation

The Steelnovo Settanta represents Colnago's rich history while embracing cutting-edge technology, making it the ultimate blend of heritage and performance.



STEELNOVO

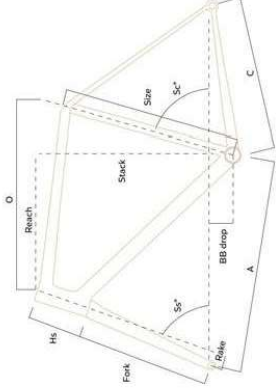

Size	Ss*	Ss*	Reach	Stack	Fork length	Rate	Hs	C	A	BB drop	(Virtual)TT(O)
420	70.8	75.5	370	512	372	43	106	410	573	74	502
455	71.6	76.3	375	525	372	43	117	410	575.3	74	513
485	72.5	78.8	382	543	372	43	135	410	580.2	72	530
510	72.9	79.5	387	562	372	43	153	410	587.3	72	543
530	72.9	79.8	394	580	372	43	172	415	599.8	72	562
550	72.9	79.5	402	599	372	43	192	415	613.5	72	579
570	72.9	79.3	409	619	372	43	213	415	626.5	72	595

Framekit: € 5.500

Groupset	Wheels	MSRP
Shimano Dura Ace D12	ENVE SES 4.5 wheels	€ 15.900,00
Campagnolo Super Record 13s	Bora Ultra WTO 45mm wheels	€ 15.400,00



V series

V4

COLNAGO

COLNAGO



COLNAGO

V4



most updated technical info
Scan the QR code for the
informationi tecniche più aggiornate
Scansiona il codice QR per le



V series

GEOMETRY

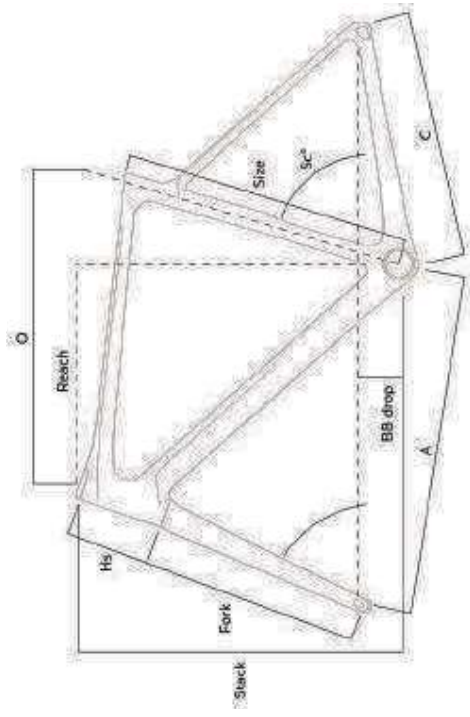

Sloping

Size	Fork	Sc°	A	C	Hs	Ss°	BBdrop	O	Stack	Reach
420	379	75,5	576	408	103	70,6	72	504	510	370
455	379	75	582	408	114	71	72	517	522	375
485	379	74,5	591	408	130	71,5	72	535	539	383
510	379	74	597	408	148	71,8	72	550	557	388
530	379	73,5	599	408	164	72,5	72	567	575	395
550	379	73	608	408	181	72,9	72	586	593	403
570	379	73	619	408	200	73,1	72	599	612	410

MAX NOMINAL TIRE CLEARANCE:30 mm

V4

Lightness and responsiveness, with the charm of Colnago

The Colnago V4 is an all-round bicycle, a bike that is extremely fun to ride and has a clean and refined design. The frame is a monocoque which is stiff, solid, reactive, and which enjoys the same carbon layup R&D and aerodynamic studies that led to the realization of the V4RS.

Leggerezza e reattività, con il fascino di Colnago

La Colnago V4 è una bicicletta a tutto tondo, estremamente divertente da guidare e dal design pulito e raffinato. Il telaio è un telaio monoscocca rigido, solido e reattivo, che gode della stessa ricerca e sviluppo sul layup del carbonio e degli stessi studi aerodinamici che hanno portato alla realizzazione dei V4RS.

Groupset

Wheels

MSRP

Shimano Ultegra R8170 Di2 Disc	VISION SC45	€ 6.800,00
Shimano 105 R7170 Di2 Disc	VISION SC45	€ 5.200,00
Sram Rival AXS Disc	VISION SC45	€ 5.400,00



THE IMAGES SHOWN ARE INDICATIVE ONLY.
Components and graphic details may differ from the actual model.

COLOR CODE: VDDK



COLOR CODE: VDRD



COLOR CODE: VDLB



G4-X

COLNAGO





Scan the QR code for the most updated technical information
 Scansiona il codice QR per le informazioni tecniche più aggiornate

G4-X



A balanced gravel racing bike, to perform at its best in every context

The G4-X is the result of optimizing all those factors that are important when you have to compete or go hard on dirt roads: handling, lightness, downhill rideability, stability, frame responsiveness, and, like all Colnago bikes, surprisingly wonderful to ride.

Una bici da corsa gravel equilibrata, per dare il meglio di sé su ogni terreno

La G4-X è il risultato dell'ottimizzazione di tutti quei fattori che sono importanti quando si deve gareggiare o andare forte su strade sterrate: maneggevolezza, leggerezza, guidabilità in discesa, stabilità, reattività del telaio e, come tutte le bici Colnago, sorprendentemente meravigliosa da guidare.

GEOMETRY

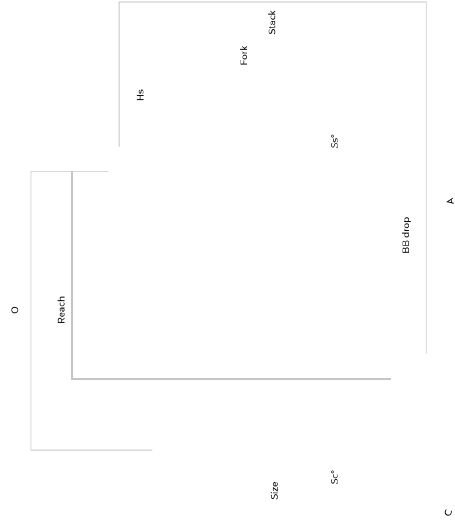

Sloping

Size	Cf	Fork	Sc°	A	C	Ss°	BBdrop	O	Stack	Reach
45s	450	406	74	585	430	71	72	524	535	371
48s	480	406	74	596	430	71,5	72	538	554	380
52s	520	406	73,5	613	430	71,5	70	559	573	390
54s	540	406	73	628	430	71,5	70	580	591	400
57s	570	406	73	644	430	71,5	70	596	610	410

MAX NOMINAL TIRE CLEARANCE: 45 mm



COLOR CODE: MTYL

G4-X

G4-X		Groupset	Wheels	MSRP
		Sram Red AXS E1	VISION SC 45	€8.870,00
		Sram Force XPLR E1	VISION SC 45	€6.400,00
		Sram Rival XPLR 13s	VISION SC 45	€5.200,00
		Shimano GRX 825 2x	VISION SC 45	€6.400,00
		Shimano GRX 827 1x	VISION SC 45	€6.400,00
		Shimano GRX 820 2x	Fulcrum Lite ER DB	€4.330,00
		Shimano GRX 822 1x	Fulcrum Lite ER DB	€4.330,00



COLOR CODE: ICBL



COLOR CODE: PIGR



Gravel

T1RS

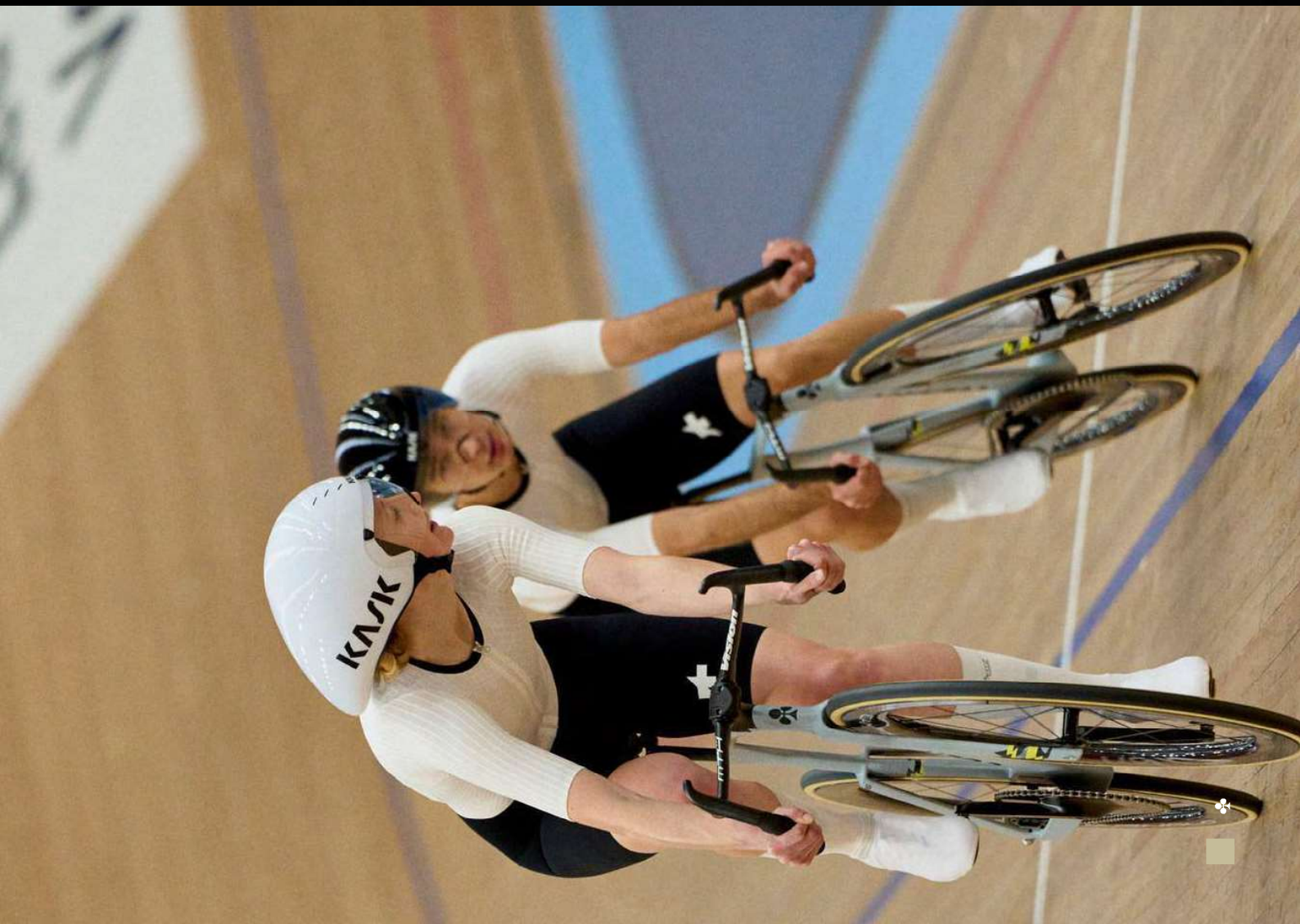

T1RS marks Colnago's return to track competitions after several years

The T1RS frame and its components have been **designed and engineered to minimize air resistance** at high speeds and to **reduce power losses**, thanks to its exceptional stiffness.

GEOMETRY

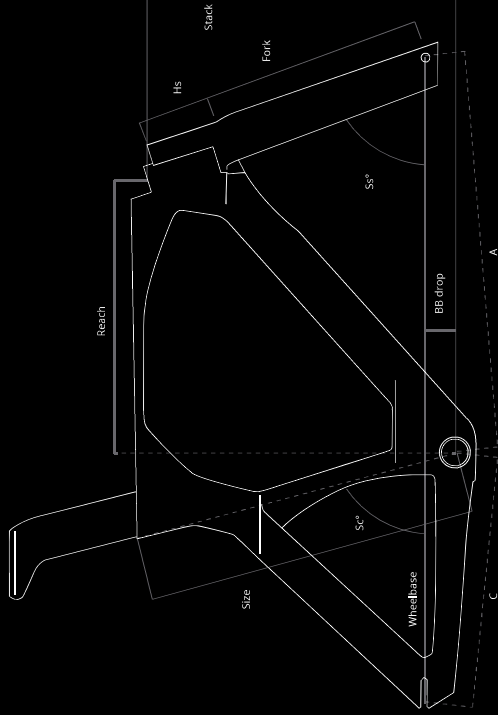

Size	Stack	Reach	SS°	SC°	A	C	Wheelbase	HS	Rake	Fork Length	BB drop
S	468	417	73	77,5	594	387	977	75	44,5	372	55
M	494	430	73	77,5	614	387	997	100,5	44,5	372	55
L	520	461	73	76,5	652	387	1036	121	44,5	372	55

bottle and bottlecage included

Frame	MSRP
Only Kit Frame available	€ 6.500,00



TT2



TT2

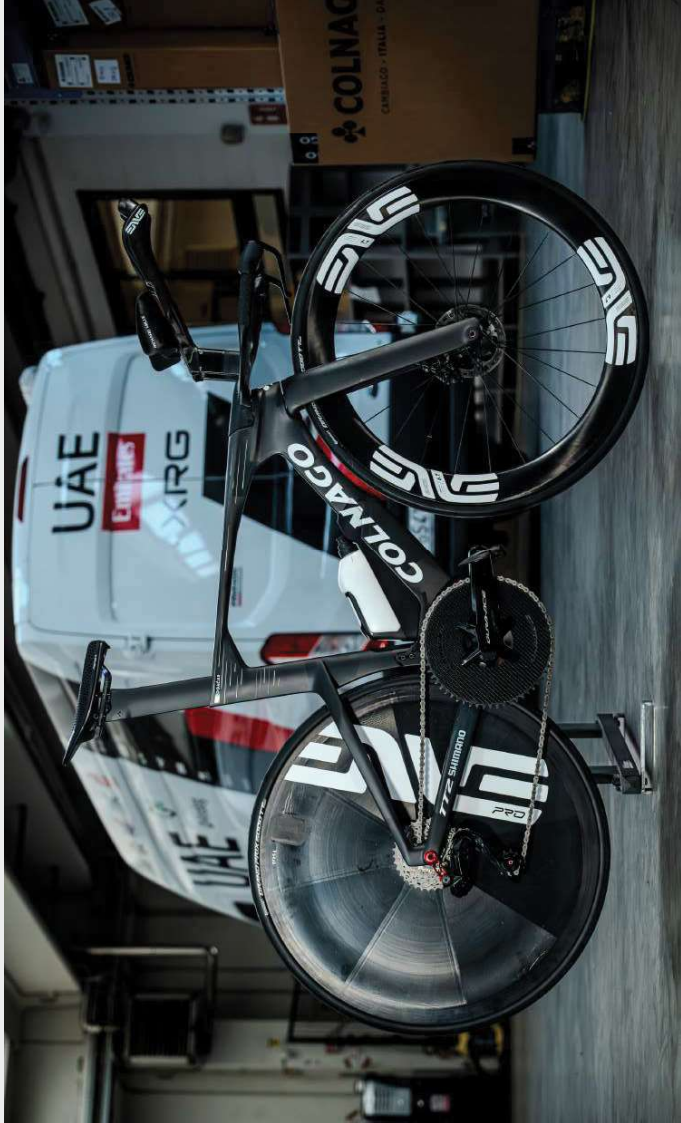

ONLY KIT FRAME AVAILABLE

The frame kit includes:

- Frame
- Fork
- Seatpost
- Basebars
- Colnago bottlecage and Bottle with Fidlock system
- Small parts (bearings etc.)

TT1

Frame	MSRP
only kit frame available	€ 7.040,00

GEOMETRY

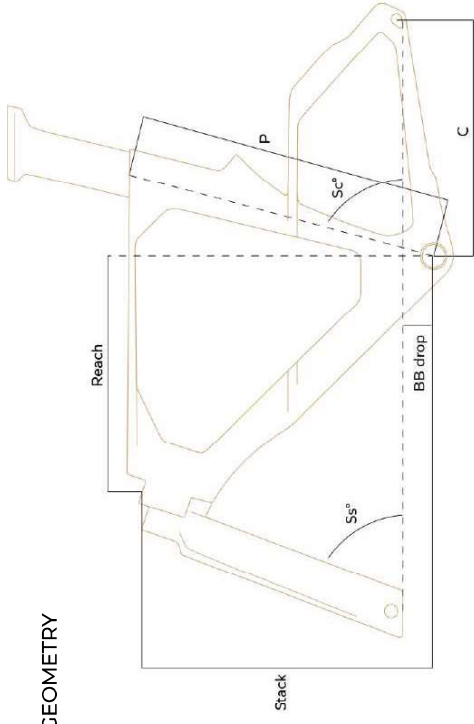

	X	S	M	L
Stack (Frame)	468	473	501	523
Reach (Frame)	385	400	415	430
Stack (Center of extension base)	499	502	530	552
Reach (Center of extension base)	466	482	497	512
Hs°	71	72.5	72.5	72.5
Ss°	76.5	76.5	77	77
Front Center	571	575	599	620
Chainstays	408	408	408	408
Wheelbase	967	972	995	1017
Fork offset	43	43	43	43
Fork Length	367	367	367	367
Trail (28-622)	70	62	62	62
BB drop	75	75	75	75
Stancover	766	771	801	824



Colnago Handlebar CC.01
C68, V5Rs, V4Rs, C68 Gravel, C68 Allroad

€899



Geometry

STEM	WIDTH	DROP
80	370	385,17
90	390	410
90	410	430
100	390	410
100	410	430
110	390	410
110	410	430
120	410	430
130	430	450

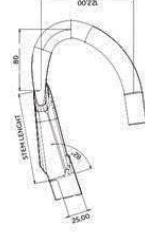
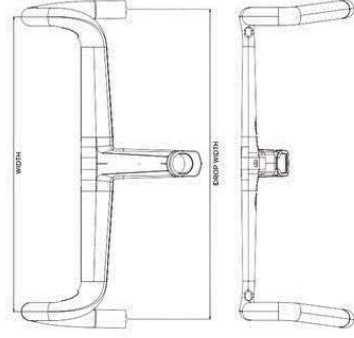

Colnago Handlebar CC.01 wide €899

ART	STEM	WIDTH/ DROP
000057053	80	40/46
000057054	90	40/46
000057055	100	40/46
000057056	110	40/46
000057057	120	40/46



Colnago Handlebar CC.Y1

with WYND© Technology

€899

Geometry

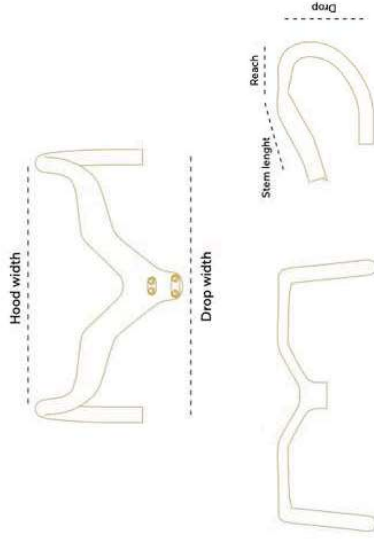

	95/377	95/397	105/377	105/397	115/377	115/397	125/377	125/397	135/377	135/397
Stem Length	95	105	105	115	115	125	125	135	135	135
Hood width	377	397	377	397	377	397	377	397	377	397
Drop width (flare)	400	420	400	420	400	420	400	420	400	420
Reach	79	79	79	79	79	79	79	79	79	79
Drop	130	130	130	130	130	130	130	130	130	130

CC.02 Cockpit

€ 899

Cockpit geometry

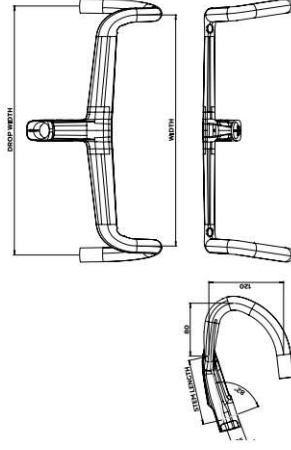

CC.02 size	Stem Length	Width	Drop width	Reach	Drop	Angle
90 - 390	90mm	390mm	420mm	80mm	120mm	82°
100 - 390	100mm	390mm	420mm	80mm	120mm	82°
100 - 390	110mm	390mm	420mm	80mm	120mm	82°
110 - 410	110mm	410mm	420mm	80mm	120mm	82°
120 - 410	120mm	410mm	420mm	80mm	120mm	82°
130 - 410	130mm	410mm	420mm	80mm	120mm	82°

Colnago Handlebar R41

€258



ART	HANDLEBAR
000056381	400
000056382	420
000056383	440

STEM SR9

€95



ART	STEM
000034079	80
000029501	90
000029502	100
000029503	110
000029504	120
000029505	130
000029506	140

Components



MULTITOOL EXPANDER - LONG

€84,00

3EXP.MTL.023.001.00BK

ART. 000041402

tg 510 - 580



MULTITOOL EXPANDER - SHORT

€84,00

3EXP.MTL.023.002.00BK

ART. 000046801

tg 420 - 490



BOTTLE CAGE

€56,00

ART	CARBON
000056385	GLOSSY
000056384	MATT



BOTTLE

€9,00

ART.000056387

Water Bottle FLY 550ML Colhago
Black



COMPUTER MOUNT

€45,00

ART	DESCRIPTION
000044747	Kit CCI computer mount + Adaptors
000047090	Kit CCI computer mount Wahoo Aero
000053765	Support arm Extra Long



BAR TAPE

€31,00

ART	COLOR
000047383	WT23
000028516	BLACK
000028515	WHITE
000028518	RED
000028517	BLUE
000028524	DOT ; NERO/NERO
000028523	DOT ; NERO/BIANCO

